



GEOTUB PANEL



MANUALE TECNICO 
TECHNICAL MANUAL 

CONTENTS

PAG. 2	LIST OF COMPONENTS - LISTA COMPONENTI
PAG. 3	COLUMN COMBINATIONS - CONBINAZIONI COLONNA
PAG. 4	COLUMN ASSEMBLING [A] - ASSEMBLAGGIO COLONNA [A]
PAG. 6	COLUMN ASSEMBLING [B] - ASSEMBLAGGIO COLONNA [B]
PAG. 8	COLUMN ASSEMBLING [C] - ASSEMBLAGGIO COLONNA [C]
PAG. 10	FIXING TO THE GROUND - FISSAGGIO A TERRA
PAG. 11	COLUMN PROPPING [1] - PUNTELLAZIONE COLONNA [1]
PAG. 11	COLUMN PROPPING [2] - PUNTELLAZIONE COLONNA [2]
PAG. 12	COLUMN DISMANTLING - DISARMO COLONNA
PAG. 13	POUR GUIDELINES - PRESCRIZIONI DI GETTO
PAG. 15	OPERATION AND MAINTENANCE REQUIREMENTS - PRESCRIZIONI DI USO E MANUTENZIONE
PAG. 15	SAFETY REQUIREMENTS - PRESCRIZIONI DI SICUREZZA

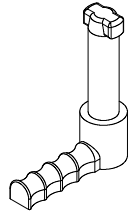
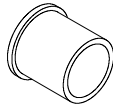
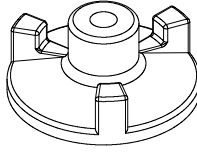
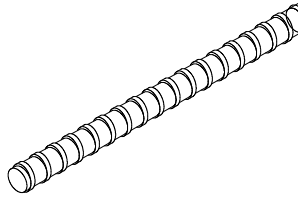
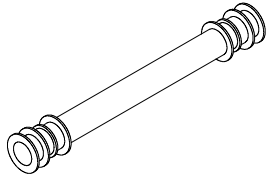
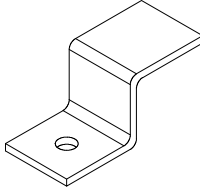
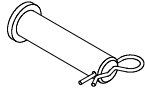
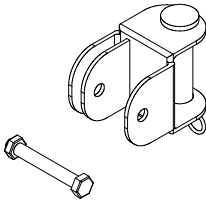
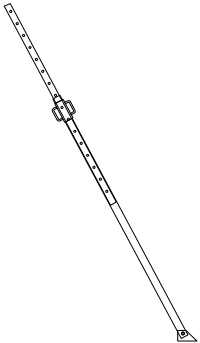
					
HANDLE	MANIGLIA	CAP Ø 25mm	TAPPO Ø 25mm	ANCHOR NUT Ø 120mm	ROSETTA Ø 120mm
					
TIE ROD	BARRA RULLATA	SPACER	DISTANZIATORE	FIXING BRACKET	STAFFA D'ANCORAGGIO
					
PIN Ø 24 WITH R-CLIP	PERNO Ø 24 CON COIPLIA	BRACE CONNECTOR AND M12 BOLT	NODO STABILIZZATORE E BULLONE M12	PUSH \ PULL PROP	PUNTELLO TIRA \ SPINGI

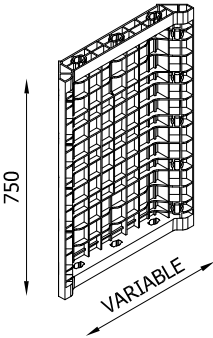
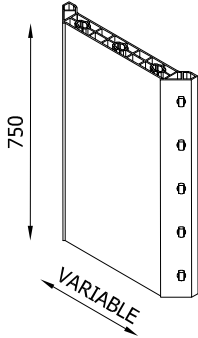
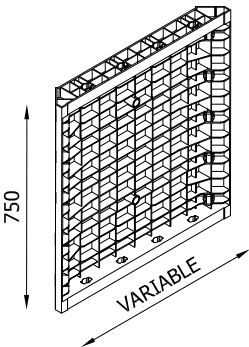
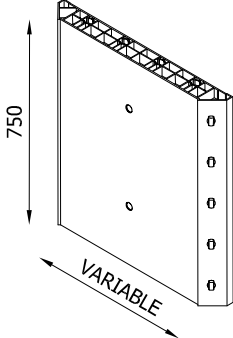
GEOTUB PANEL 20 - 25 - 30 - 35 - 40		GEOTUB PANEL 45 - 50 - 55 - 60	
			
EXTERNAL VIEW VISTA ESTERNA	INTERNAL VIEW VISTA INTERNA	EXTERNAL VIEW VISTA ESTERNA	INTERNAL VIEW VISTA INTERNA

IT IS POSSIBLE TO REALIZE 55 COLUMN COMBINATIONS WITH GEOTUB PANEL ELEMENTS, BASED ON 3 DIFFERENT ASSEMBLING METHODS (A, B, C), AS SHOWN IN THE FOLLOWING TABLE:

E' POSSIBILE REALIZZARE 55 COMBINAZIONI DI COLONNA CON ELEMENTI GEOTUB PANEL, BASATE SU 3 DIVERSI METODI DI ASSEMBLAGGIO (A, B, C), COME MOSTRATO NELLA TABELLA SUCCESSIVA:

COLUMN SIZE		COLUMN SIZE										
		[cm]	20	23	25	30	35	40	45	50	55	60
COLUMN SIZE	20	A	A	A	A	A	A	A	B	B	B	B
	23		A	A	A	A	A	A	B	B	B	B
	25			A	A	A	A	A	B	B	B	B
	30				A	A	A	A	B	B	B	B
	35					A	A	A	B	B	B	B
	40						A	A	B	B	B	B
	45								C	C	C	C
	50									C	C	C
	55										C	C
	60											C

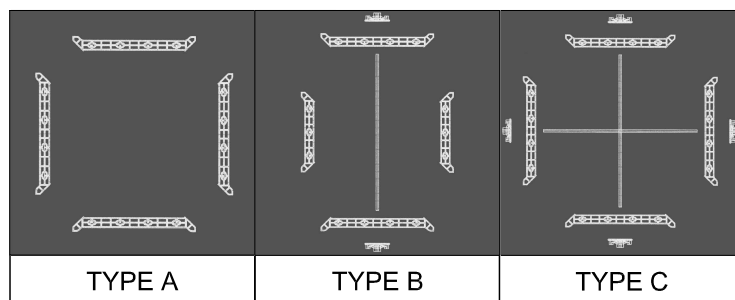

1. FIRST COLUMN CORNER INSTALLATION
 INSTALLAZIONE PRIMO ANGOLO DELLA COLONNA

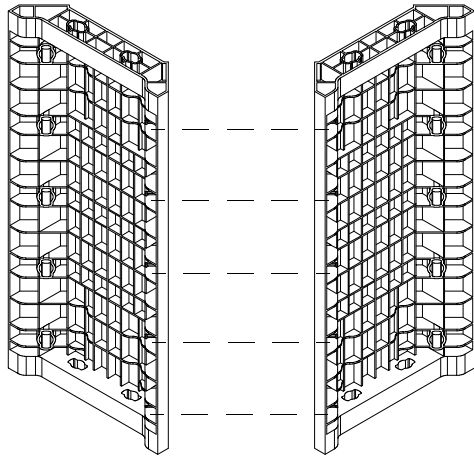

2. GEOTUB PANEL ELEMENTS FIXING WITH HANDLES
 FISSAGGIO ELEMENTI GEOTUB PANEL CON MANIGLIE

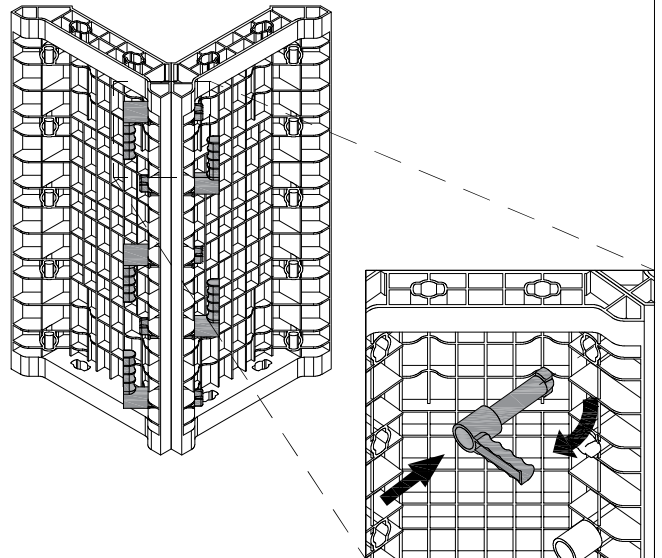

3. SECOND COLUMN CORNER INSTALLATION
 INSTALLAZIONE SECONDO ANGOLO DELLA COLONNA

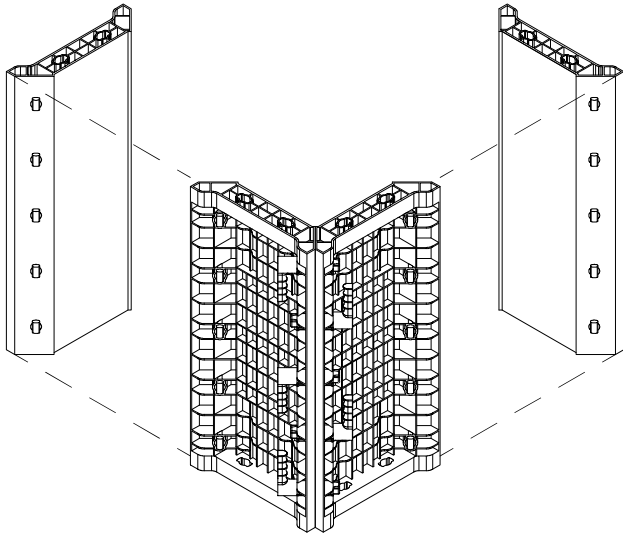

4. SECOND LEVEL OF GEOTUB PANEL ASSEMBLING
 ASSEMBLAGGIO SECONDO LIVELLO GEOTUB PANEL

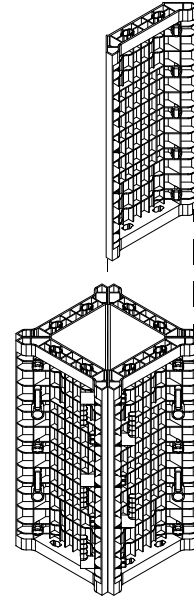

5. GEOTUB PANEL ELEMENTS FIXING WITH HANDLES
 FISSAGGIO ELEMENTI GEOTUB PANEL CON MANIGLIE

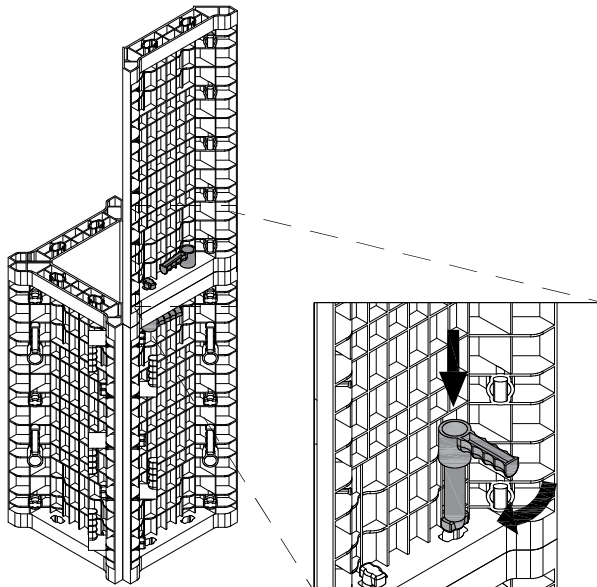

6. SECOND LEVEL OF GEOTUB ASSEMBLING
 ASSEMBLAGGIO SECONDO LIVELLO GEOTUB

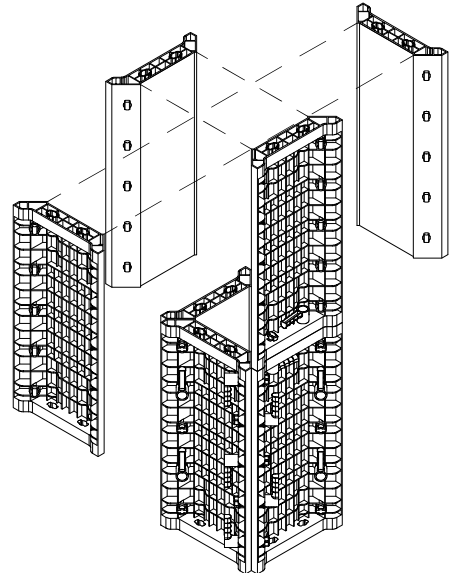

FINAL RESULT

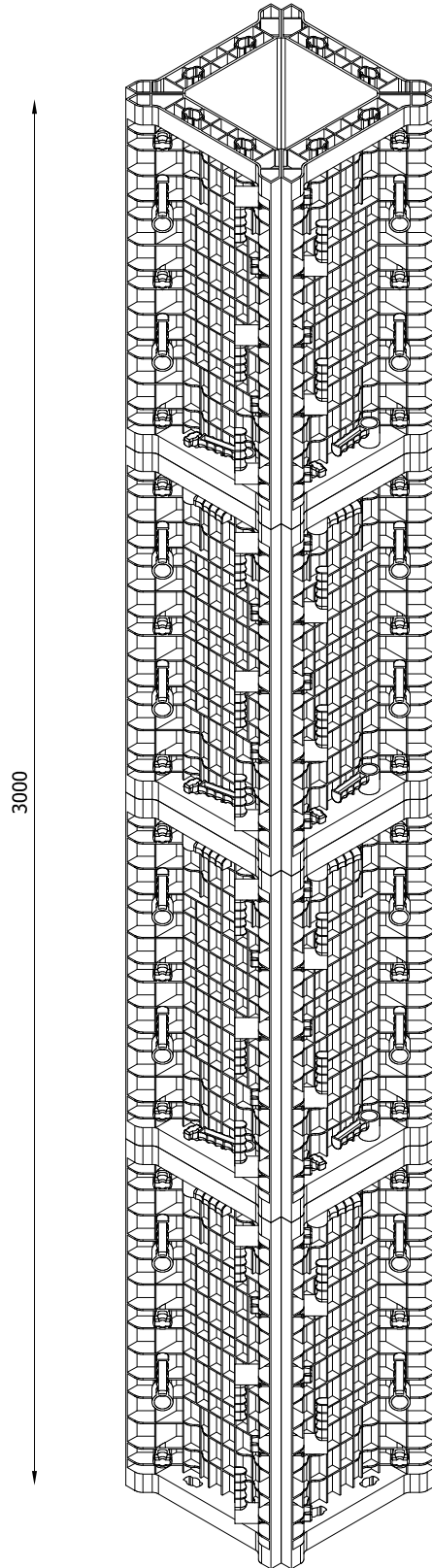

1. FIRST COLUMN CORNER INSTALLATION
 INSTALLAZIONE PRIMO ANGOLO DELLA COLONNA

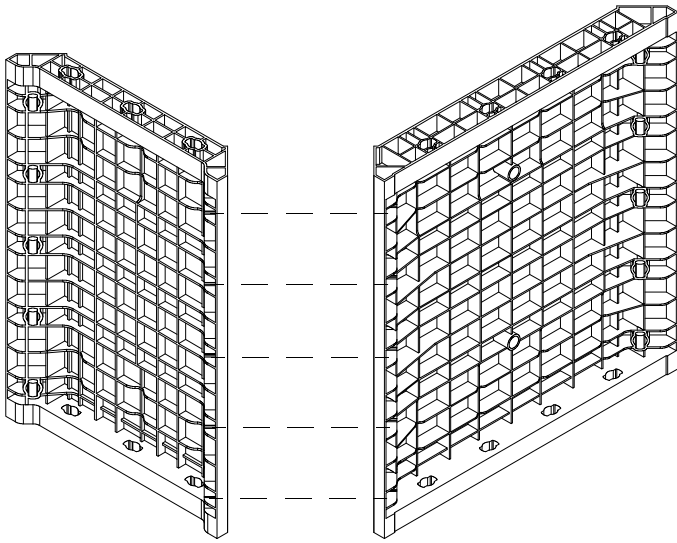

2. GEOTUB PANEL ELEMENTS FIXING WITH HANDLES
 FISSAGGIO ELEMENTI GEOTUB PANEL CON MANIGLIE

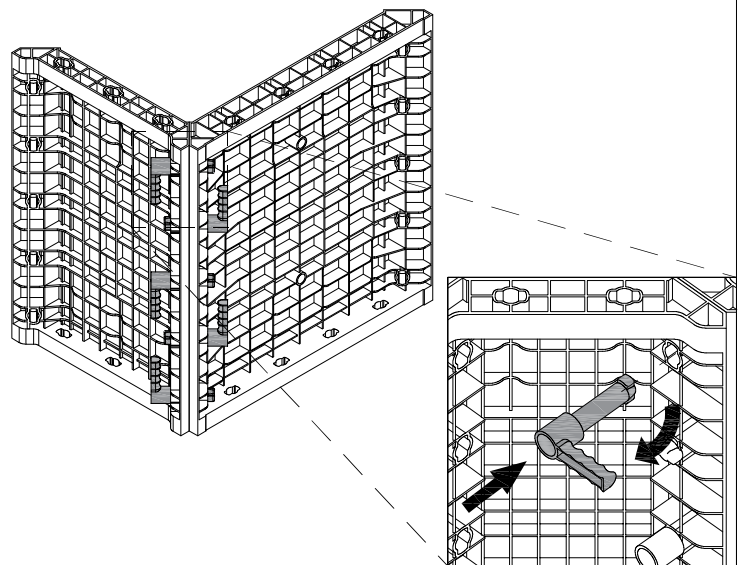

3. TIE RODS AND SPACERS INSTALLATION
 INSTALLAZIONE BARRE RULLARE E Distanziatori

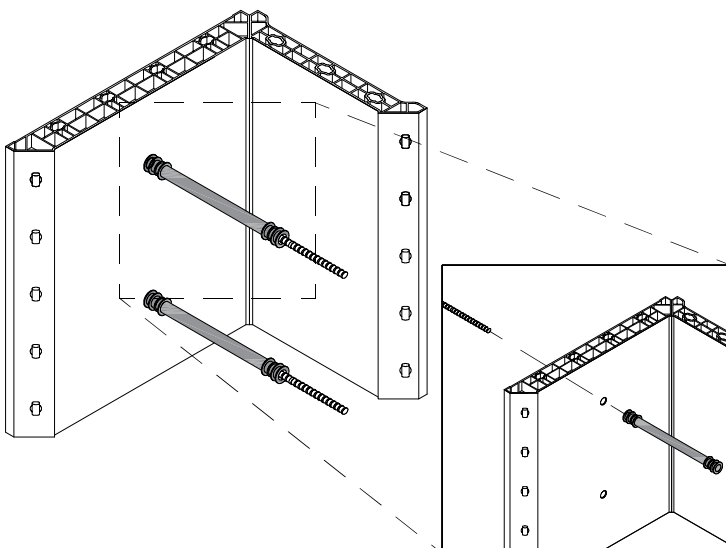

4. SECOND COLUMN CORNER INSTALLATION
 INSTALLAZIONE SECONDO ANGOLO DELLA COLONNA

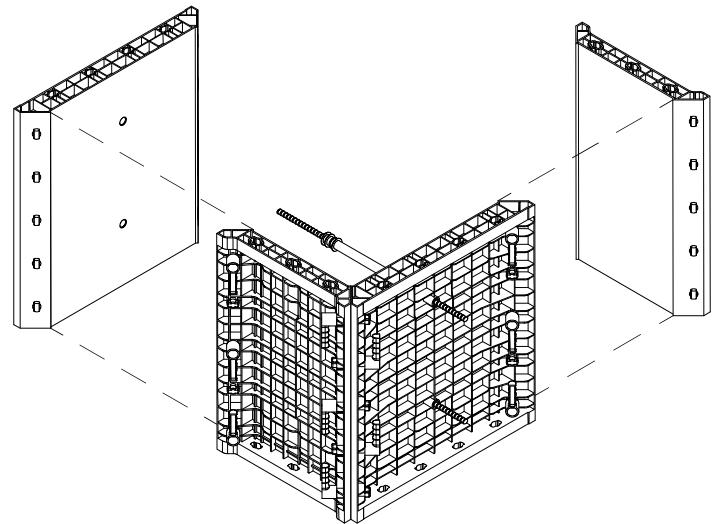

5. SECOND LEVEL OF GEOTUB PANEL ASSEMBLING
 ASSEMBLAGGIO SECONDO LIVELLO GEOTUB PANEL

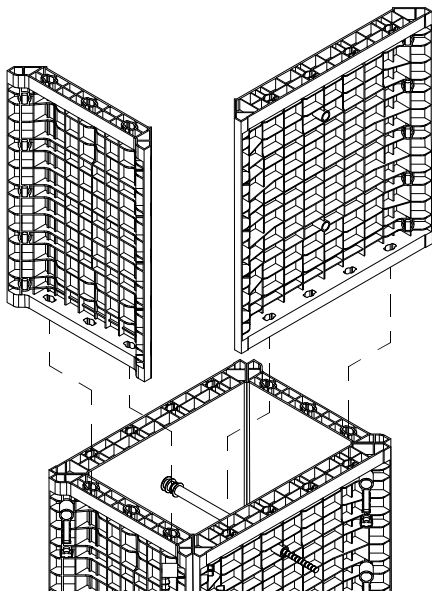

6. GEOTUB PANEL ELEMENTS FIXING WITH HANDLES
 FISSAGGIO ELEMENTI GEOTUB PANEL CON MANIGLIE

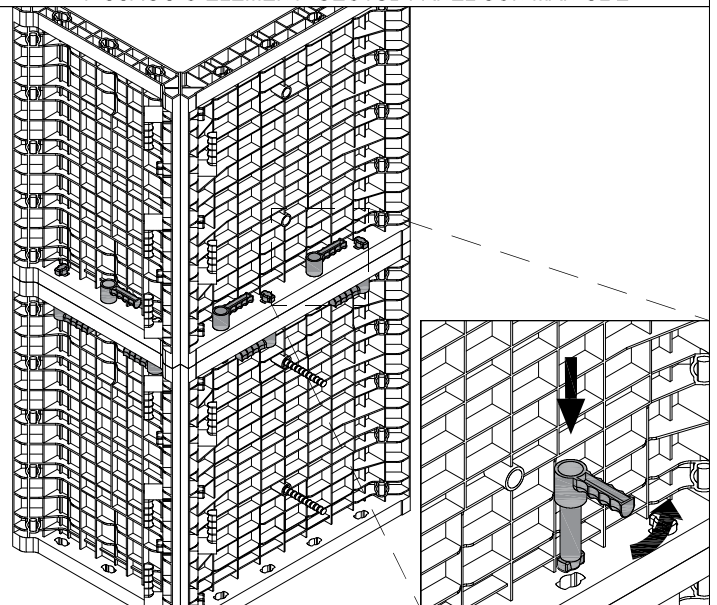

7. CAPS Ø25 INSTALLATION ON THE UPPER PANELS
INSTALLAZIONE TAPPI Ø25 NEI PANNELLI SUPERIORI

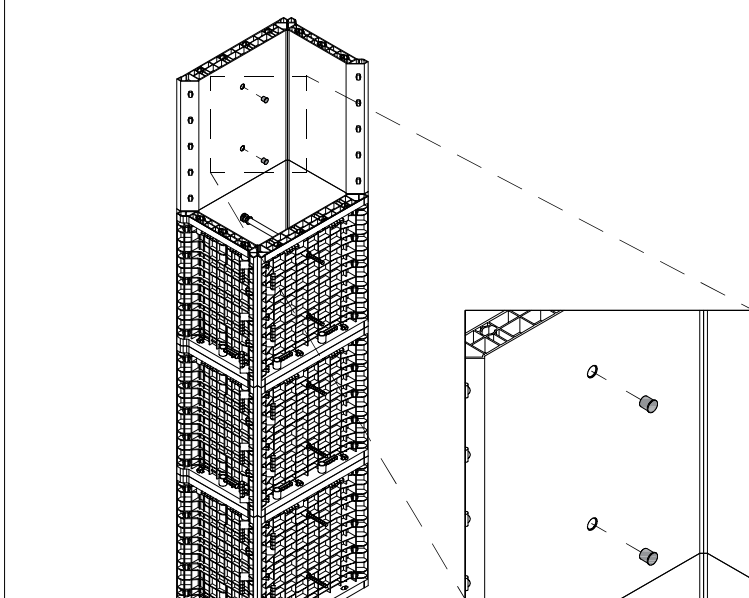

8. ANCHOR NUTS INSTALLATION
INSTALLAZIONE ROSETTE

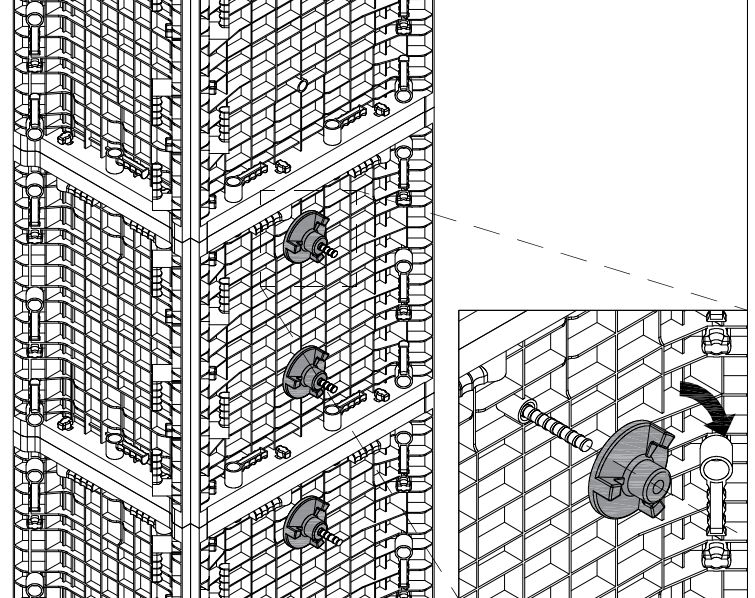

FINAL RESULT

3000

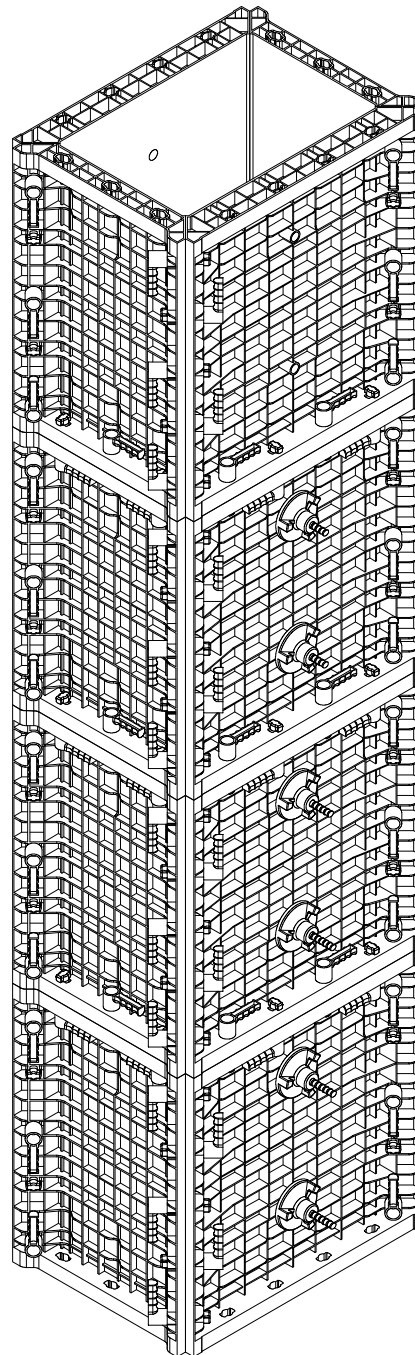

1. FIRST COLUMN CORNER INSTALLATION
 INSTALLAZIONE PRIMO ANGOLO DELLA COLONNA

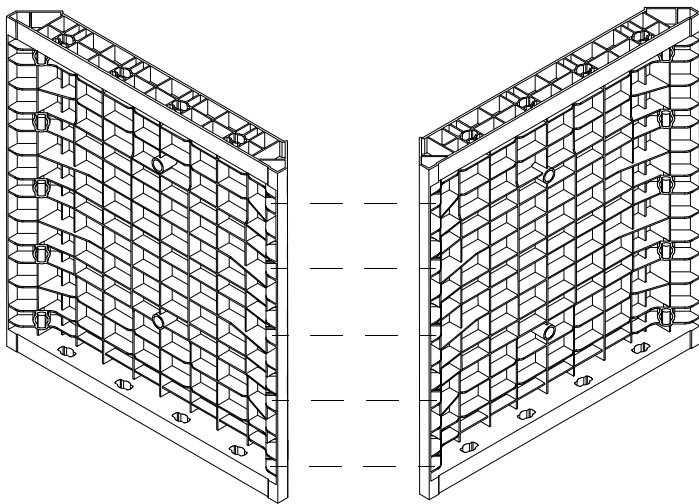

2. GEOTUB PANEL ELEMENTS FIXING WITH HANDLES
 FISSAGGIO ELEMENTI GEOTUB PANEL CON MANIGLIE

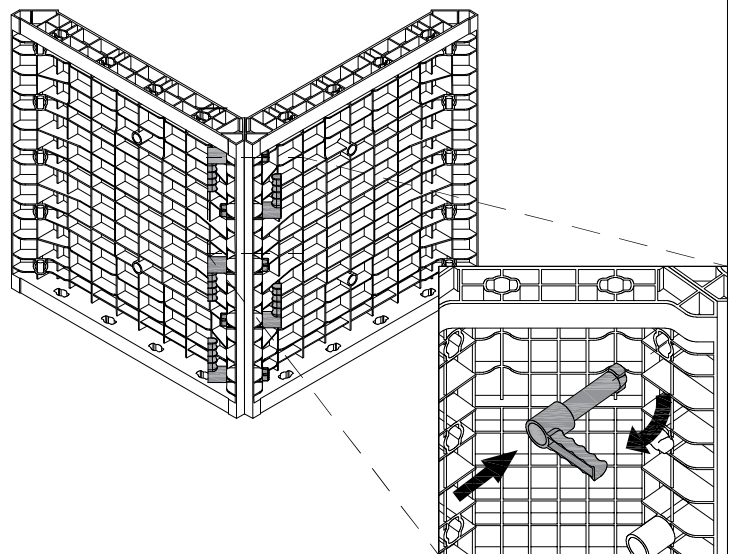

3. TIE RODS AND SPACERS INSTALLATION
 INSTALLAZIONE BARRE RULLARE E DISTANZIATORI

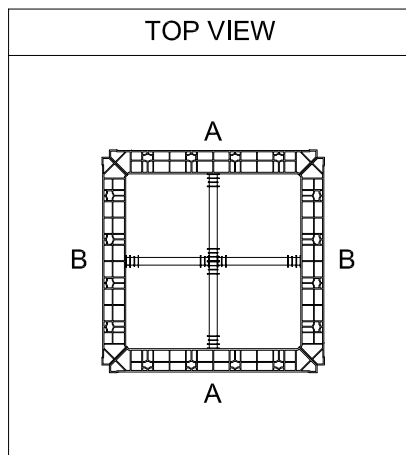
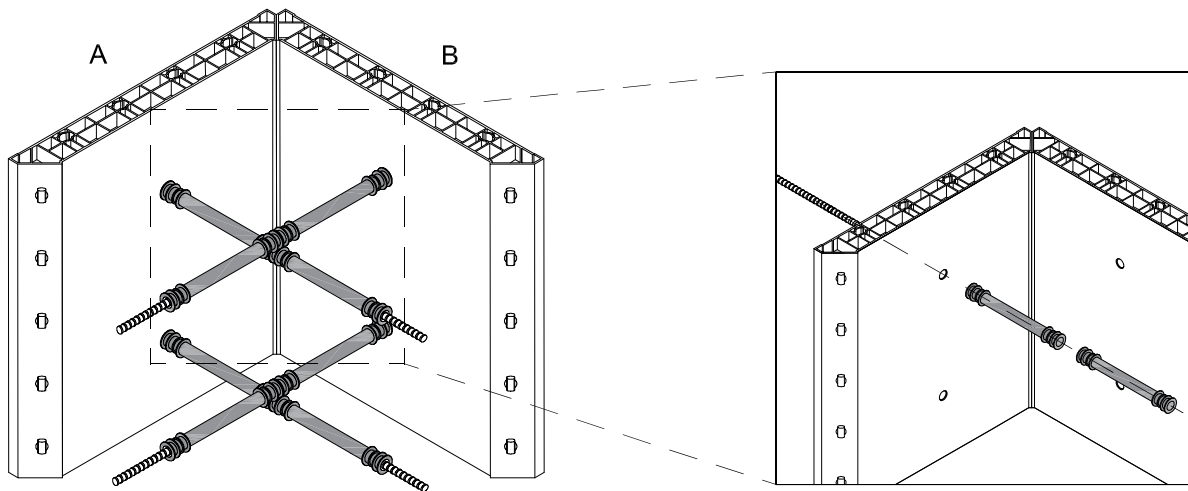

"A" POSITION

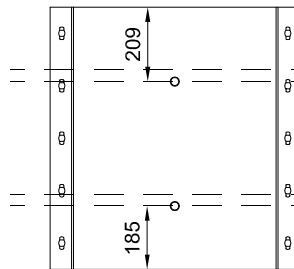

"B" POSITION

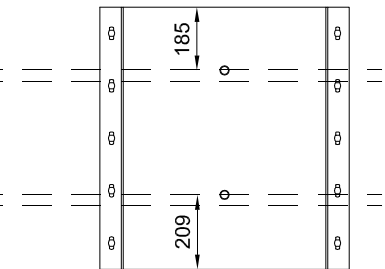

4. SECOND COLUMN CORNER INSTALLATION
 INSTALLAZIONE SECONDO ANGOLO DELLA COLONNA

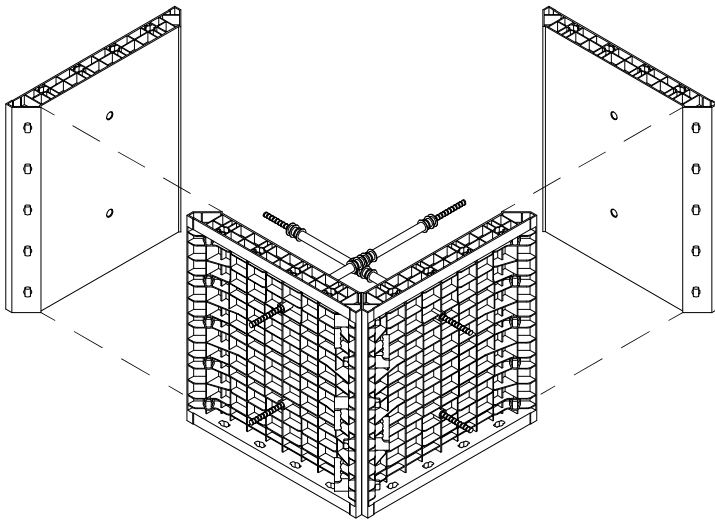

5. SECOND LEVEL OF GEOTUB PANEL ASSEMBLING
 ASSEMBLAGGIO SECONDO LIVELLO GEOTUB PANEL

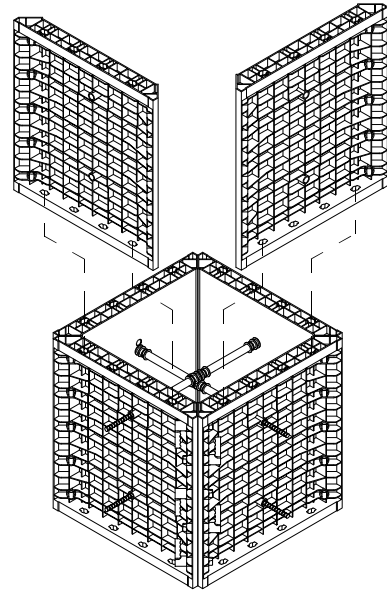

6. GEOTUB PANEL ELEMENTS FIXING WITH HANDLES
 FISSAGGIO ELEMENTI GEOTUB PANEL CON MANIGLIE

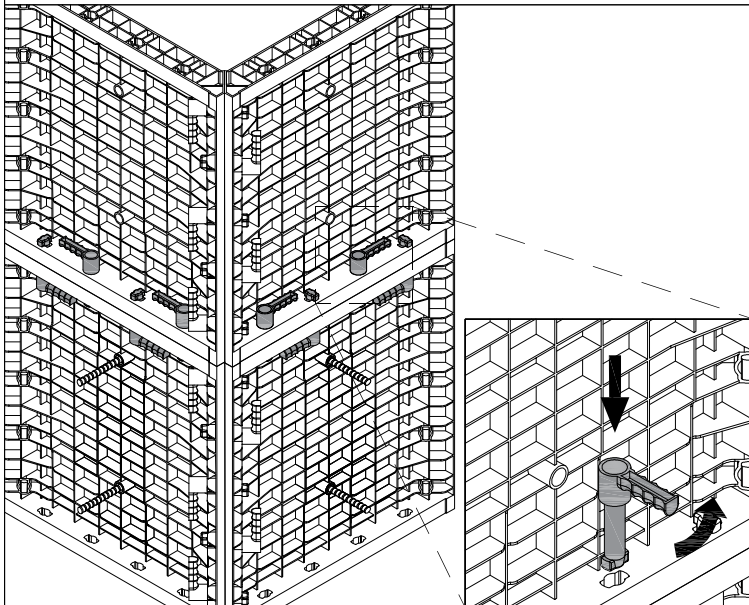

7. CAPS Ø25 INSTALLATION ON THE UPPER PANELS
 INSTALLAZIONE TAPPI Ø25 NEI PANNELLI SUPERIORI

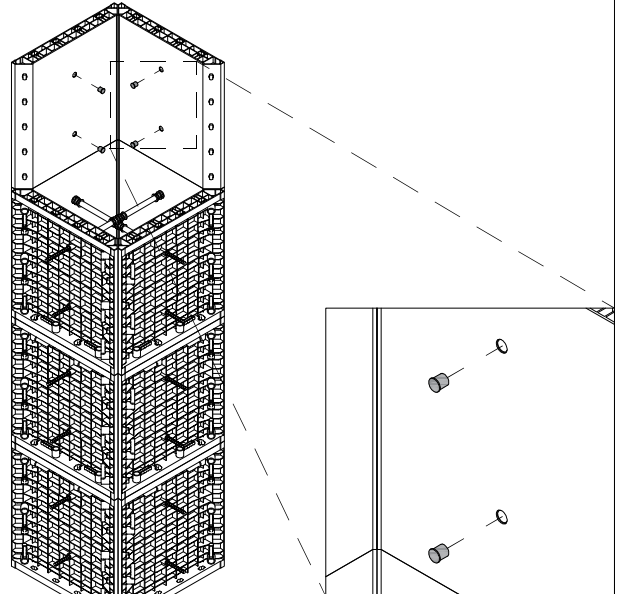

8. ANCHOR NUTS INSTALLATION
 INSTALLAZIONE ROSETTE

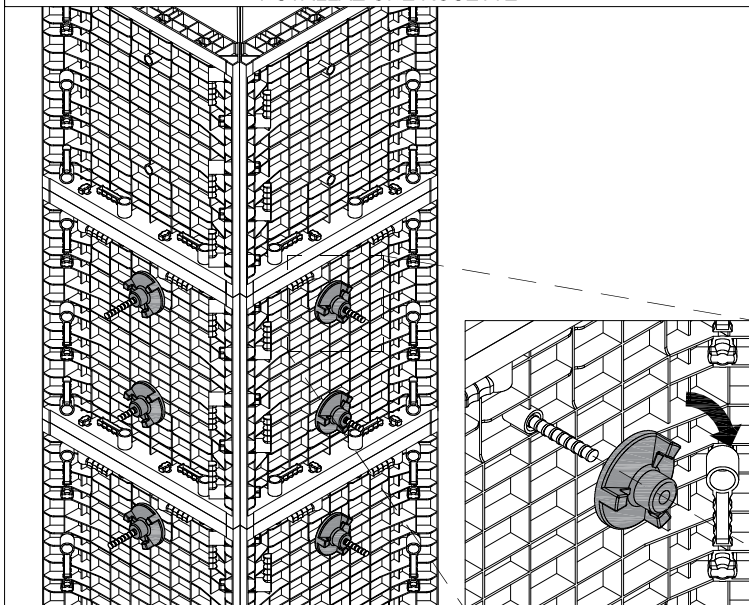

FINAL RESULT

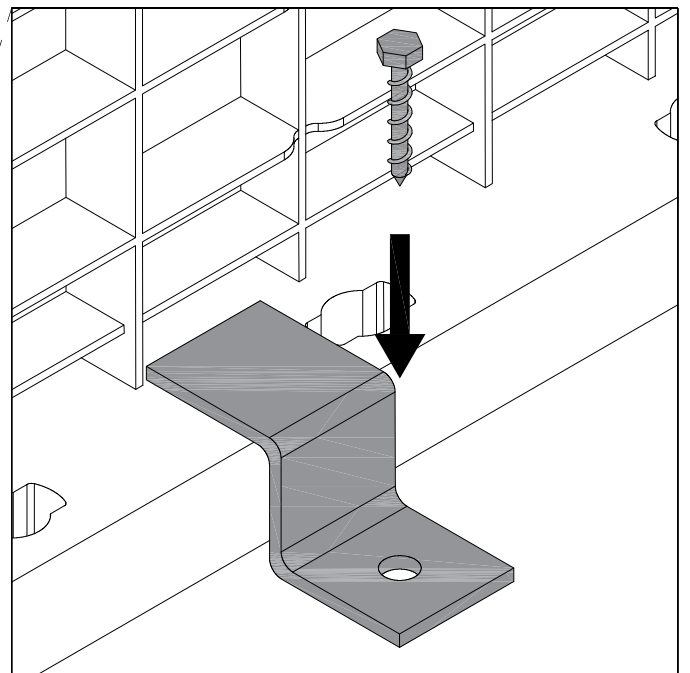
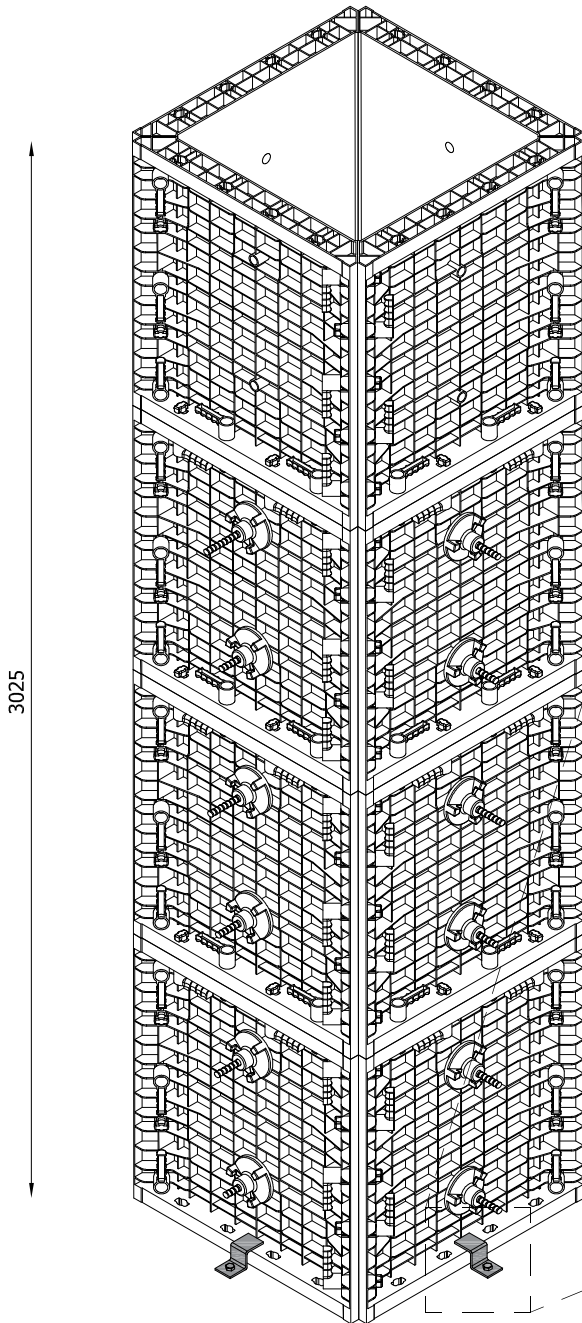

COLUMN PROPPING [1]

PUNTELLAZIONE COLONNA [1]

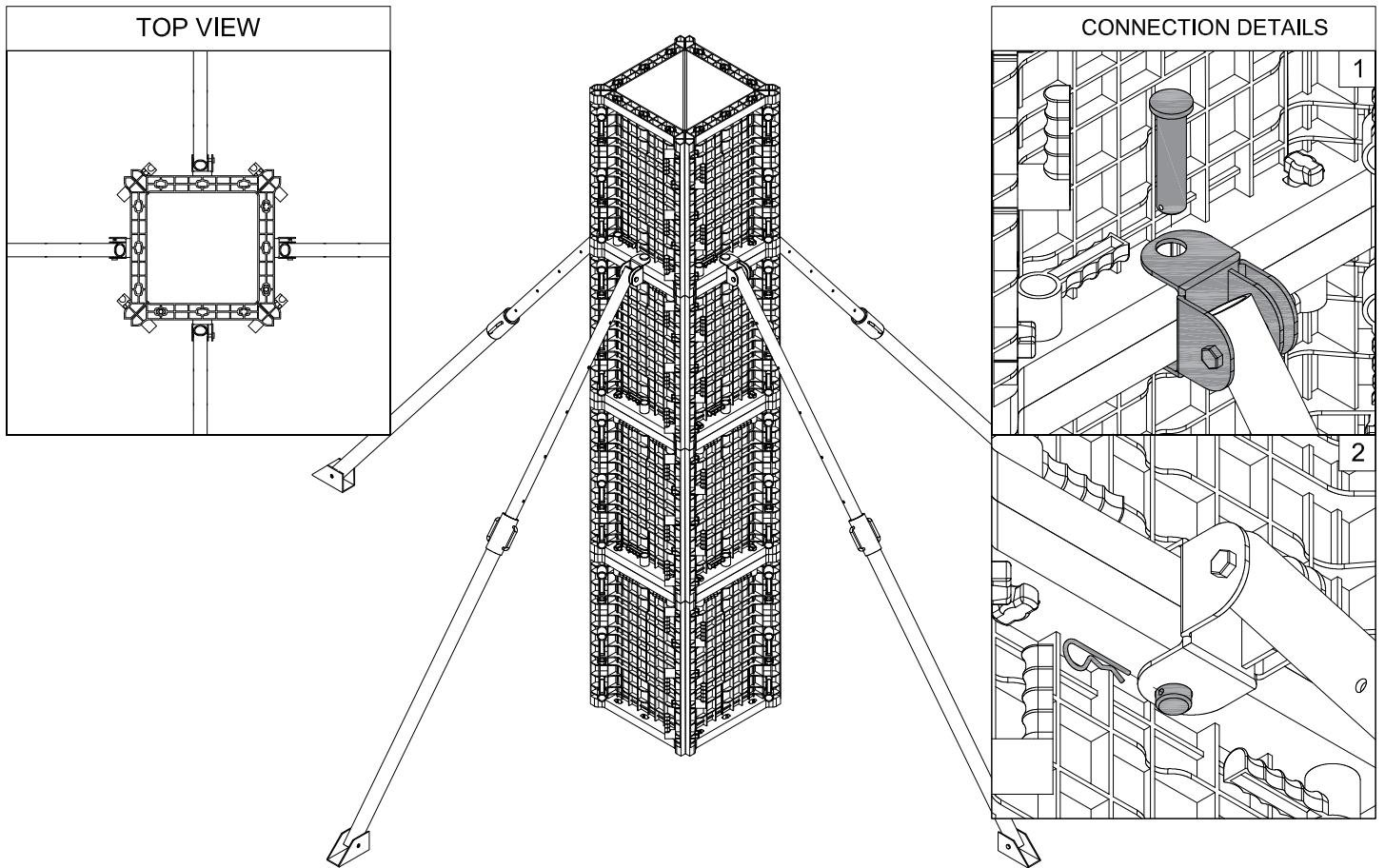

COLUMN PROPPING [2]

PUNTELLAZIONE COLONNA [2]

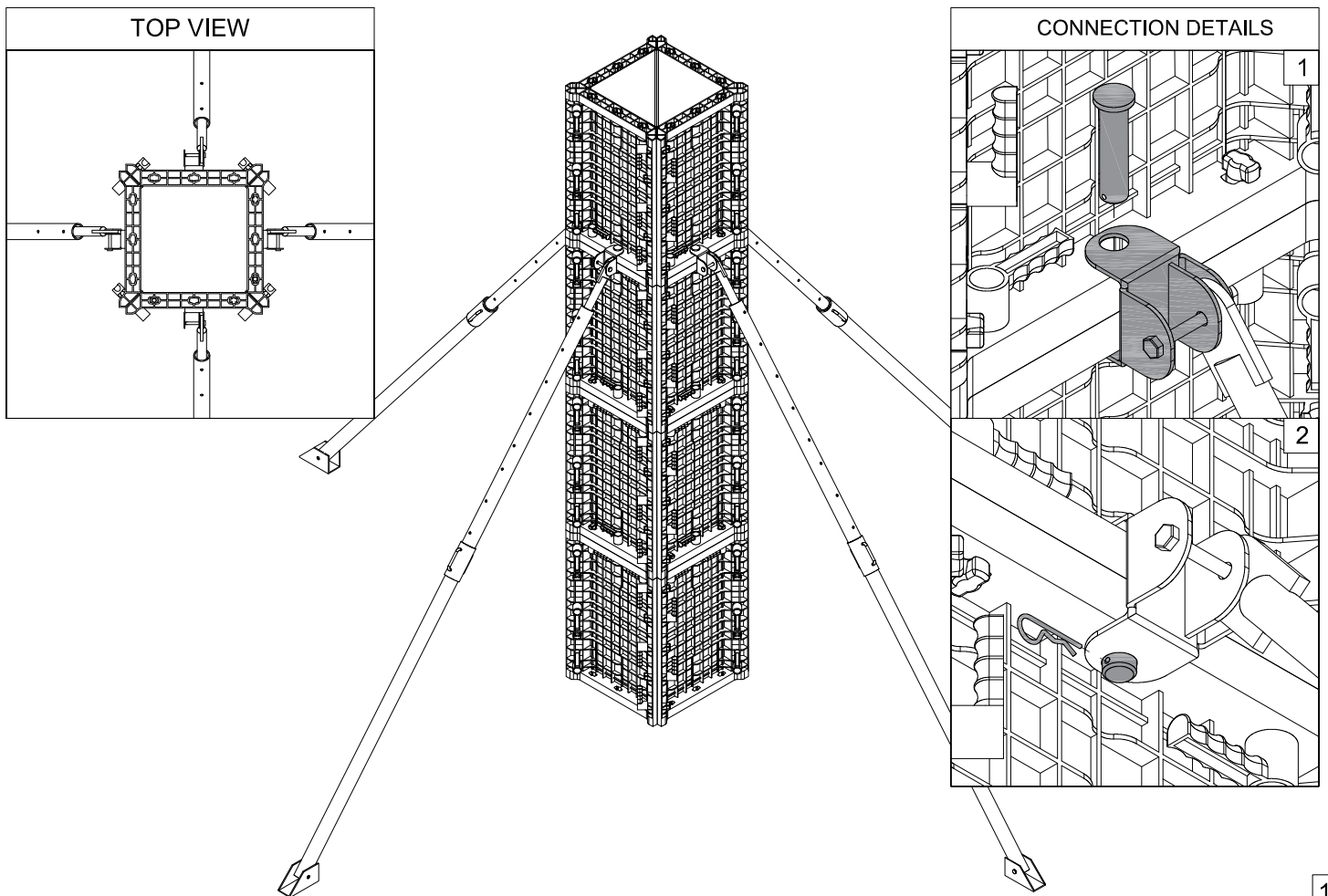

1. VERTICAL HANDLES REMOVING
RIMOZIONE MANIGLIE VERTICALI

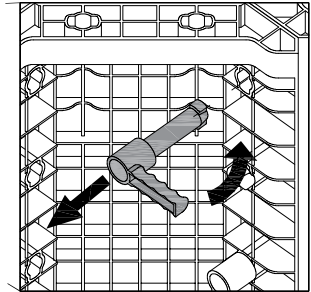
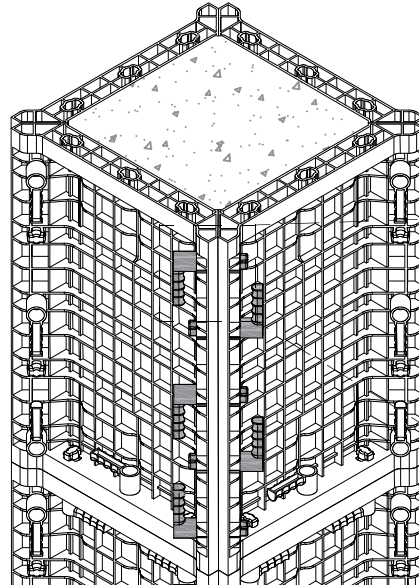
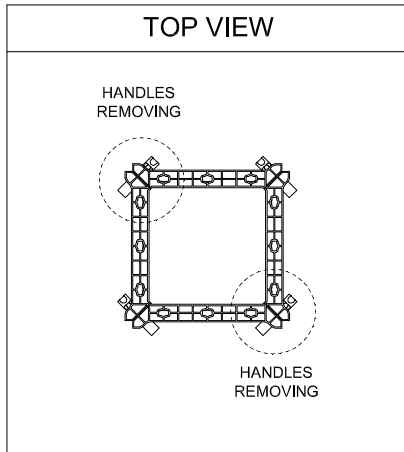

2. GEOTUB PANEL REMOVING
RIMOZIONE GEOTUB PANEL

IT IS POSSIBLE TO MOVE HALF COLUMN FORMWORK IN THE DISMANTLING PHASE

E' POSSIBILE MUOVERE META' CASSEFORMA DELLA COLONNA IN FASE DI DISARMO

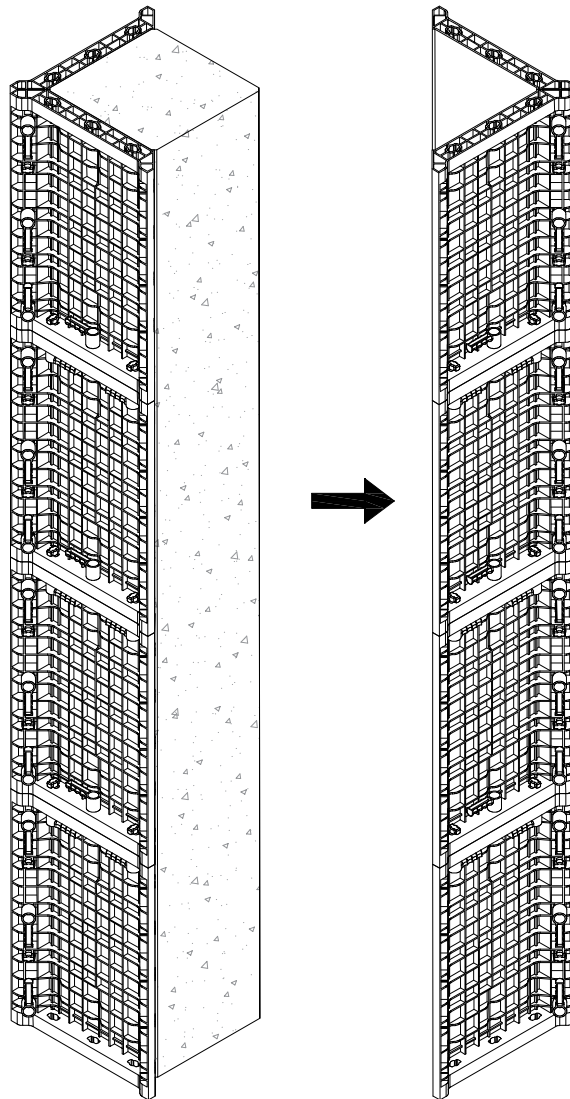

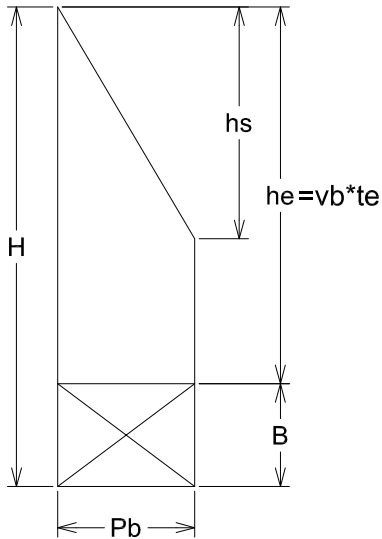

H = total height of the pour
 hs = height of hydrostatic pressure,
 i.e. maximum depth of fresh concrete pressure P_b
 he = pour height
 vb = pour speed
 te = time (hours) from the time of mixing until pour completed
 B = set concrete
 P_b = maximum horizontal value of the fresh concrete pressure on formwork

H = altezza totale del getto
 hs = altezza pressione idrostatica,
 ossia profondità massima della pressione del calcestruzzo fresco P_b
 he = altezza di getto
 vb = velocità di getto
 te = tempo (ore) dal momento della miscelazione fino al getto completato
 B = calcestruzzo solidificato
 P_b = massimo valore orizzontale della pressione del calcestruzzo fresco sul cassero

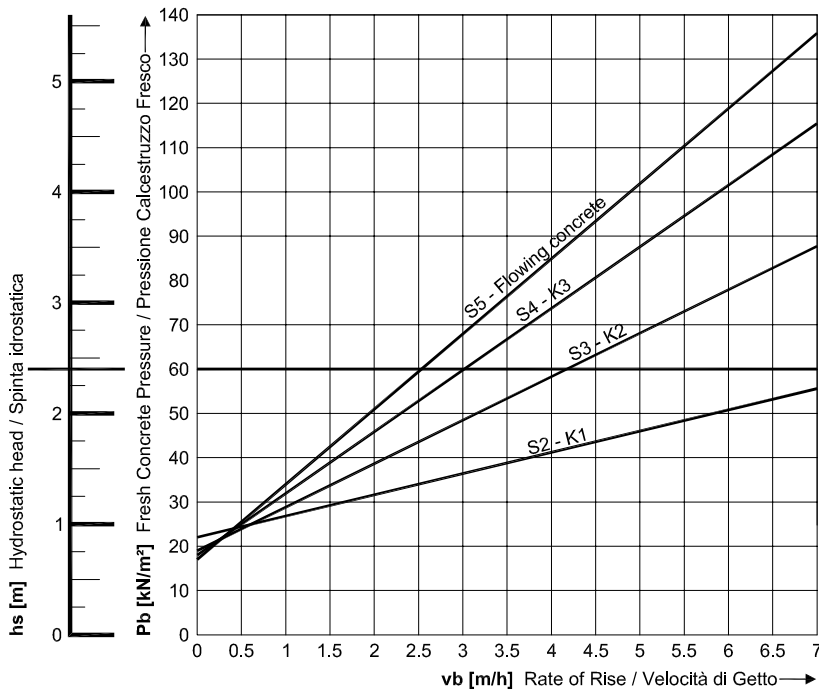

MAXIMUM PERMISSIBLE PRESSURE OF FRESH CONCRETE: 60kN

Assumptions:

- Specific weight of fresh concrete: 25 kN/m³
- Concrete set time: 5h
- Concrete temperature at placement: +15°C
- Concrete compacting with immersion vibrator

SPINTA MASSIMA DEL CALCESTRUZZO FRESCO SOPPORTATA DEL CASSERO: 60kN

Assunzioni:

- Peso specifico calcestruzzo compattato: 25 kN/m³
- Tempo di presa massimo: 5h
- Temperatura calcestruzzo al momento del getto: +15°C
- Compattazione con vibratori ad immersione

GEOTUB PANEL: MAX POUR HEIGHT 3.00 m

GEOTUB PANEL: MASSIMA ALTEZZA DI GETTO 3.00 m

SAFETY NOTICE

IN THE CASE OF POURS HIGHER THAN SHOWN IN THESE TABLES AND CHARTS PLEASE CONTACT THE TECHNICAL DEPT. OF GEOPLAST.

AVVISO DI SICUREZZA

PER ALTEZZE SUPERIORI A QUELLE RIPORTATE DALLE TABELLE, CONTATTARE L'UFFICIO TECNICO GEOPLAST.

CONSISTENCY CLASS	CLASSE DI CONSISTENZA	UNI EN 206:2006		DIN 18218	
		CLASSIFICAZIONE CLASSIFICATION	SLUMP	CLASSIFICAZIONE CLASSIFICATION	SPREADING
wet	umida	S1	10 ÷ 40 mm		
stiff	plastica	S2	50 ÷ 90 mm	F1 (K1)	≤ 34 cm
plastic	semifluida	S3	100 ÷ 150 mm	F2 (K2)	35 ÷ 41 cm
soft	fluida	S4	160 ÷ 210 mm	F3 (K3)	42 ÷ 48 cm
flowing	superfluida	S5	≥ 220 mm	F4 (flowing)	49 ÷ 55 cm

ABRAMS CONE
CONO DI ABRAMS

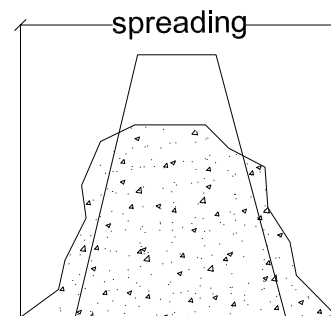
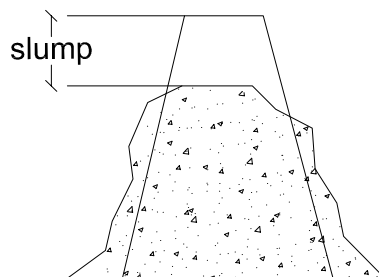

Use of retarding agent modify the concrete pressure through these coefficients.
NOTE: according to UNI EN 206:2006 and UNI 11104:2004

Utilizzando agenti ritardanti la pressione del calcestruzzo deve essere modificata attraverso i seguenti coefficienti.
NOTE: secondo normative UNI EN 206:2006 e UNI 11104:2004

CONSISTENCY CLASS	CLASSE DI CONSISTENZA	CLASSIFICATION / CLASSIFICAZIONE		SET TIME / TEMPO DI PRESA					
		UNI EN 206:2006	DIN 18218	5h	6h	7h	8h	9h	10h
stiff	plastica	S2	F1 (K1)	1.15	1.21	1.27	1.33	1.39	1.45
plastic	semifluida	S3	F2 (K2)	1.25	1.36	1.47	1.58	1.69	1.80
soft	fluida	S4	F3 (K3)	1.40	1.55	1.70	1.85	2.00	2.15

POUR

Only immersion type concrete vibrators are approved for use. The ABS formwork is not fireproof, do not place close to free flame or hot objects.

HANDLING

Use the lifting clamp to transport the formwork with a crane. Before lifting make sure the load is symmetrical and that the leg lengths are equal. Follow the diagram on p. 25 for the correct use of the lifting clamp.

ABS FORMWORK CLEANING

ABS is a particularly smooth and non-porous material on which concrete has difficulty adhering.

After each use, clean the formwork jet-washers, preferably using a high-pressure cleaner with a maximum pressure of 1.000 bar max. We recommend removing any concrete build-up with the help of plastic scrapers or brushes.

In the case of old concrete residues or encrustations that are particularly difficult to remove, we recommend cleaning with suitable concrete remover products based on vegetal oils.

The application of products containing alcohol or polycyclic aromatic hydrocarbons (PAH), such as benzene, is not permitted.

APPLICATION OF RELEASE AGENTS

As long as the contact surface of ABS formwork shows no signs of wear, no release agent is required prior to pouring.

Only release agents based on vegetal oils may be used, i.e. these must not contain (even in minute concentrations) polycyclic aromatic hydrocarbons (PAH), such as benzene.

ABS formwork may only be treated with vegetable oil-based products.

STORAGE

Store formwork in a dry place, away from heat sources and out of direct sunlight.

GETTO

Sono ammessi solamente sistemi di vibrazione ad immersione. Il cassero un ABS non è ignifugo, non porre a contatto diretto con corpi incandescenti o a fiamma libera.

MOVIMENTAZIONE

Utilizzare il gancio per Geopanel per sollevare i pannelli con gru e, prima della movimentazione, assicurarsi che le funi di sollevamento abbiano un uniforme tiraggio. Seguire lo schema di pag. 44 per il corretto utilizzo del gancio.

PULIZIA DEI PRODOTTI IN ABS

L'ABS è un materiale particolarmente liscio e non poroso sul quale il calcestruzzo ha difficoltà ad aderire.

Al termine di ogni utilizzo pulire i casseri con getti di acqua, preferibilmente utilizzando un'idropulitrice con pressione massima di 1.000 bar. Si consiglia di rimuovere eventuali incrostazioni del calcestruzzo con l'ausilio di spatole o spazzole in plastica.

In caso di vecchi residui di calcestruzzo o incrostazioni particolarmente difficili da rimuovere, si consiglia l'intervento di pulizia tramite prodotti decapanti a base oli vegetali.

Non è consentita l'applicazione di prodotti contenenti alcool o idrocarburi policiclici aromatici (IPA), come ad esempio benzene.

APPLICAZIONE DI PRODOTTI DISTACCANTI

Finché la superficie di contatto dei prodotti in ABS non mostra segni di usura, non è necessario alcun agente distaccante prima del getto.

È permesso l'utilizzo di prodotti distaccanti solo a base di oli vegetali, quindi questi non devono contenere (nemmeno in minime concentrazioni) idrocarburi policiclici aromatici (IPA), come ad esempio benzene.

I casseri in ABS possono essere trattati solo con prodotti a base di oli vegetali.

STOCCAGGIO

Stoccare i prodotti in ABS in luoghi asciutti, distanti da fonti di calore e al riparo dalla luce diretta del sole.

The operations of placing, assembly, disassembly, plumb, handling and cleaning of the Geopanel product, as well as the pouring of the concrete must be carried out by qualified and properly trained personnel, or under the supervision of the Site Manager or an Engineer of Geoplast SpA, who must ensure that:

- all the above operations are carried out in a workmanlike manner,
- every person working with the formwork is equipped with suitable tools and personal protective equipment to perform all necessary actions in compliance with the safety standards,
- all panels and the supplied accessories are checked before use, and that any part that does not meet the minimum standards of reliability and safety due to deformation or breakage is discarded,
- the formwork is installed on a perfectly flat surface, so as to work in maximum safety conditions and guarantee perfect propping and plumb,
- all connection, alignment and plumb accessories of the formwork are tight and fixed to the ground before beginning the pour.

Geoplast SpA disclaims any liability arising from improper use of the formwork Geopanel. Any assembly of formwork and/or use of accessories otherwise described in this manual must first be approved by Geoplast SpA.

Le operazioni di posizionamento, montaggio, smontaggio, messa a piombo, movimentazione e pulizia del prodotto Geopanel, nonché del getto del calcestruzzo, devono essere effettuate da personale competente e debitamente istruito o comunque sotto il controllo del responsabile di cantiere oppure di un tecnico Geoplast SpA, i quali devono assicurarsi che:

- tutte le operazioni sopra elencate vengano svolte a regola d'arte,
- gli addetti alle operazioni sopra elencate siano muniti di idonea strumentazione e di dispositivi di protezione individuale per poter effettuare tutte le azioni nel pieno rispetto delle norme di sicurezza,
- tutti i pannelli e gli accessori in dotazione vengano controllati prima del loro utilizzo, in modo tale da poter eliminare quelli che non abbiano sufficiente garanzia di affidabilità a causa di eventuali presenze di rotture e/o deformazioni,
- il piano di appoggio dei casseri sia perfettamente piano, in modo da poter operare in massima sicurezza e garantire la perfetta puntellazione e piombatura dei pilastri,
- tutti gli accessori di collegamento, di allineamento e di piombatura dei casseri, siano ben serrati e fissati al suolo prima di iniziare le operazioni di getto.

Geoplast SpA declina ogni responsabilità derivante da un uso improprio dei casseri Geopanel. Eventuali assemblaggi dei casseri e/o uso di accessori diversamente illustrati in questo manuale, devono essere prima approvati da Geoplast SpA.



GEOPLAST S.p.A.

35010 Grantorto PD - Italia - Via Martiri della Libertà, 6/8
tel +39 049 9490289 - fax +39 049 9494028
e-mail: geoplast@geoplast.it - www.geoplast.it

